

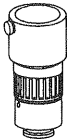

LEICA GZ6 Series

10X Eyepiece 13410750 <i>Two Required</i>	15X Eyepiece 13410752 <i>Two Required</i>	20X Eyepiece 13410753 <i>Two Required</i>
10X Pointer K2947	15X & 20X Pointer K2956	
10X Focusing Eyepiece K2933	15X Focusing w/Photo Reticle Eyepiece K2933P	





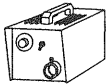
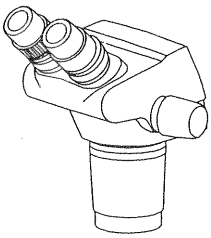
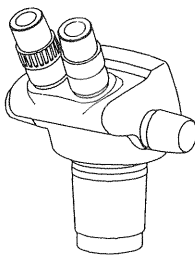
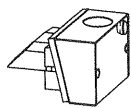

 Photo Coupler 13410302	 1/2" CCD Video Coupler 13410306	 2/3" CCD Video Coupler 13410307	 Fiber Optic Light Source <i>(or other compatible)</i> 120V - 313050 230V - 313062
---	--	--	--

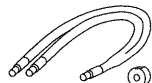
 LEICA GZ6E Stereomicroscope 13410106E	 LEICA GZ6 Stereomicroscope 13410106
--	--

Image Port
13410301



Coaxial Illumination System
13410300

Bifurcated Light Guide w/7.92mm Adapter
13410304

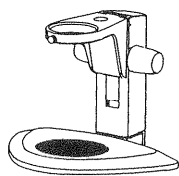
 Lens Shield 13410810	 0.5X Supp. Lens 13410801	 0.75X Supp. Lens 13410802
 1.5X Supp. Lens K3012	 2X Supp. Lens 13410804	 Adj. Supp. Lens 13410807

Basic Stand
13445635

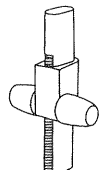
Basic Focusing Arm
13445632

Focus Drive w/Column
10445615

Microscope Carrier
13445617

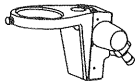

Mountable Focusing Arm
13445633



Basic Base
13445630



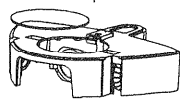

Large Base
10445631

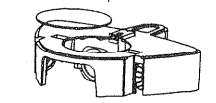

Transmitted Light Base Brightfield
10445387



Transmitted Light Base Brightfield/Darkfield
10445363

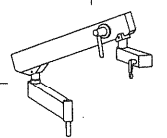

Sub Base w/Reflector
13446634

Sub Base w/Reflector 120/230V Transformer
K3015

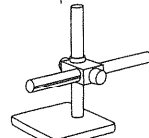
 312611	 312612
 312613	 312614

Flex Arm Stand
312610

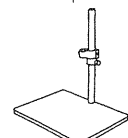
Swing Arm Stand
312714

Post Stand
312582